

1 MAIN ROOF SCREEN TYPICAL
SCALE: 6"=1'-0"

REF: 1/A9.424

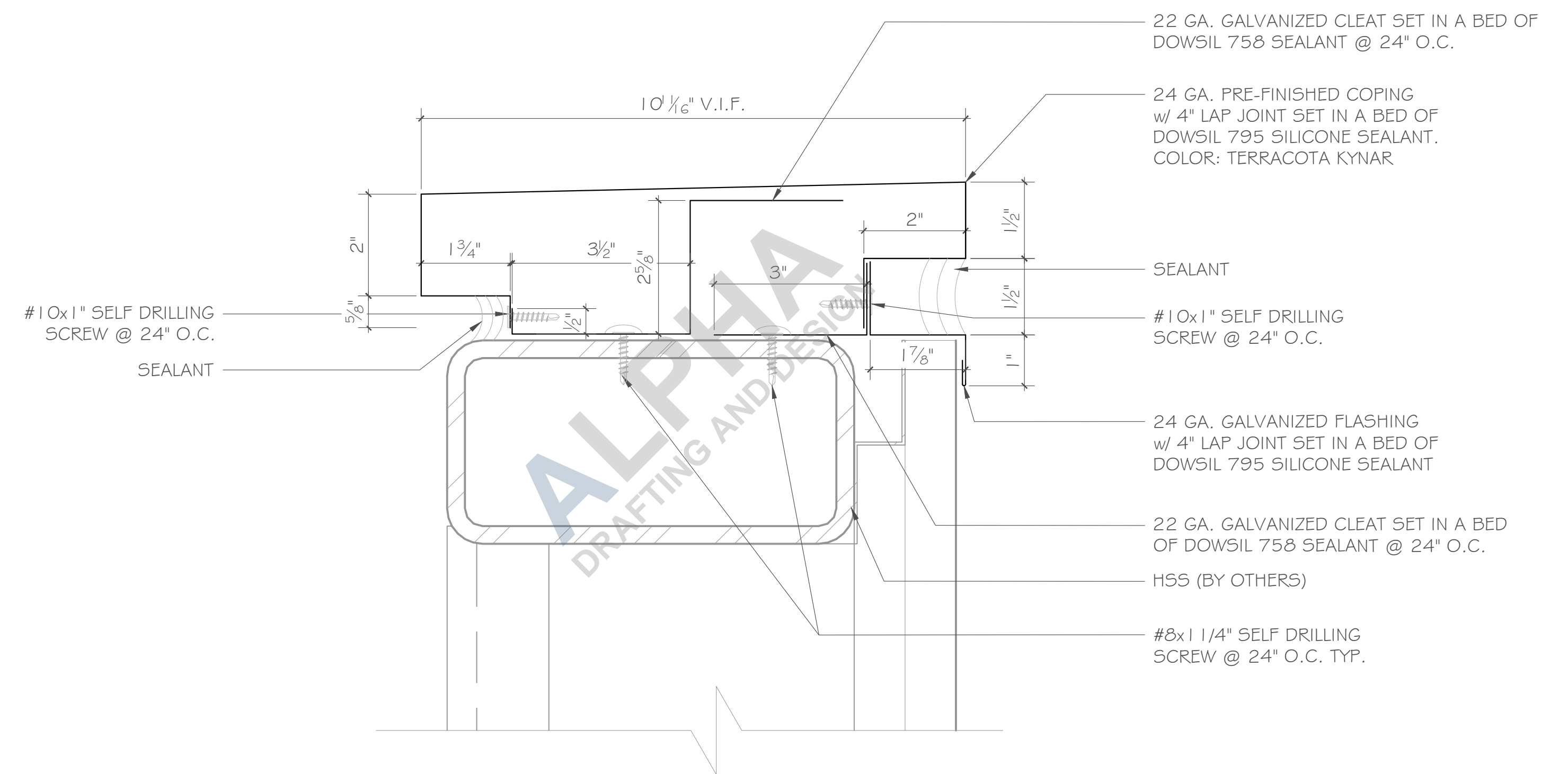

3 PAVILLION SCREEN DETAIL
SCALE: 6"=1'-0"

REF: 1/A9.425

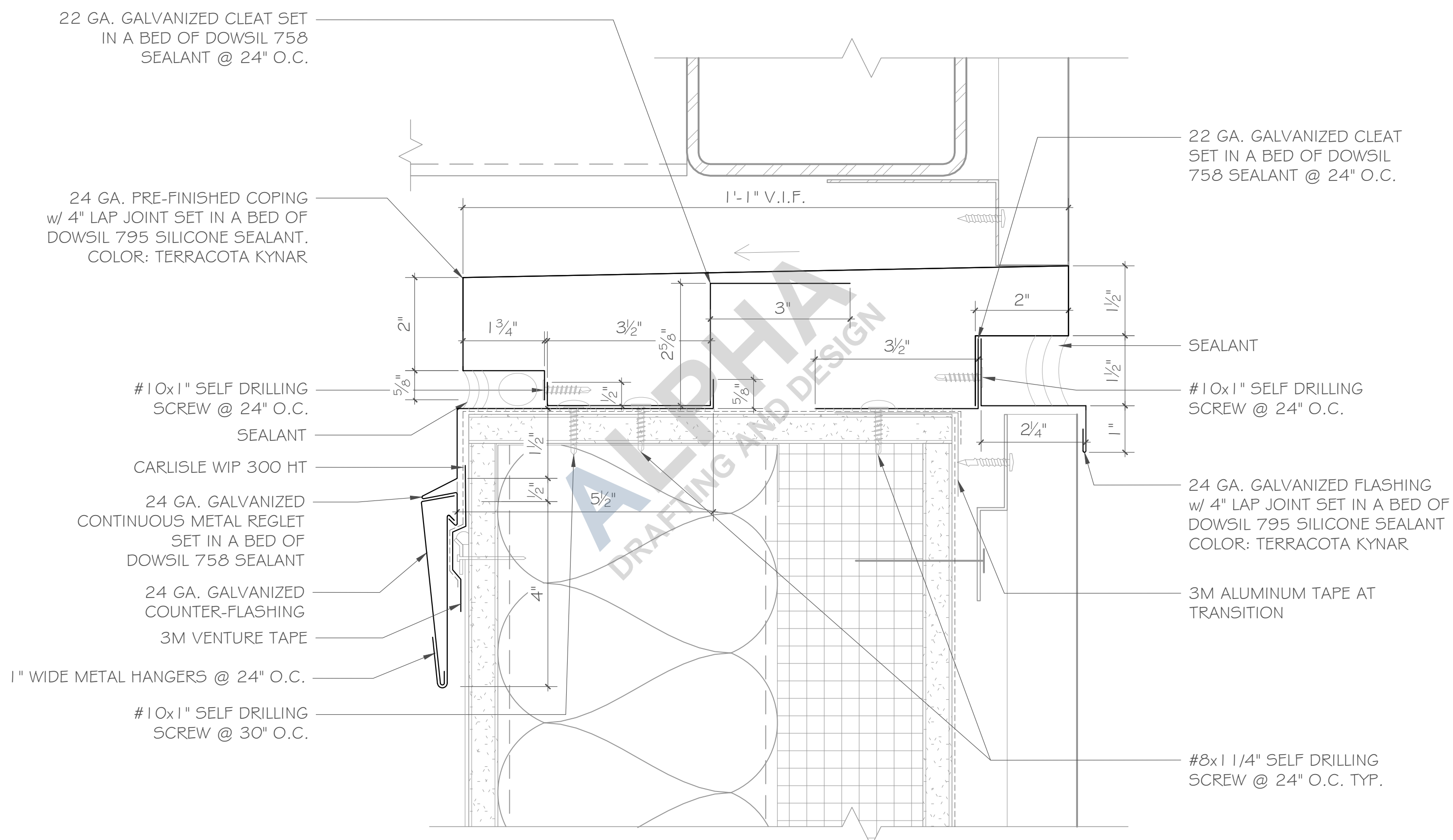

2 METAL PANEL WALL COPING AT RO1
SCALE: 6"=1'-0"

REF: 4/A9.507

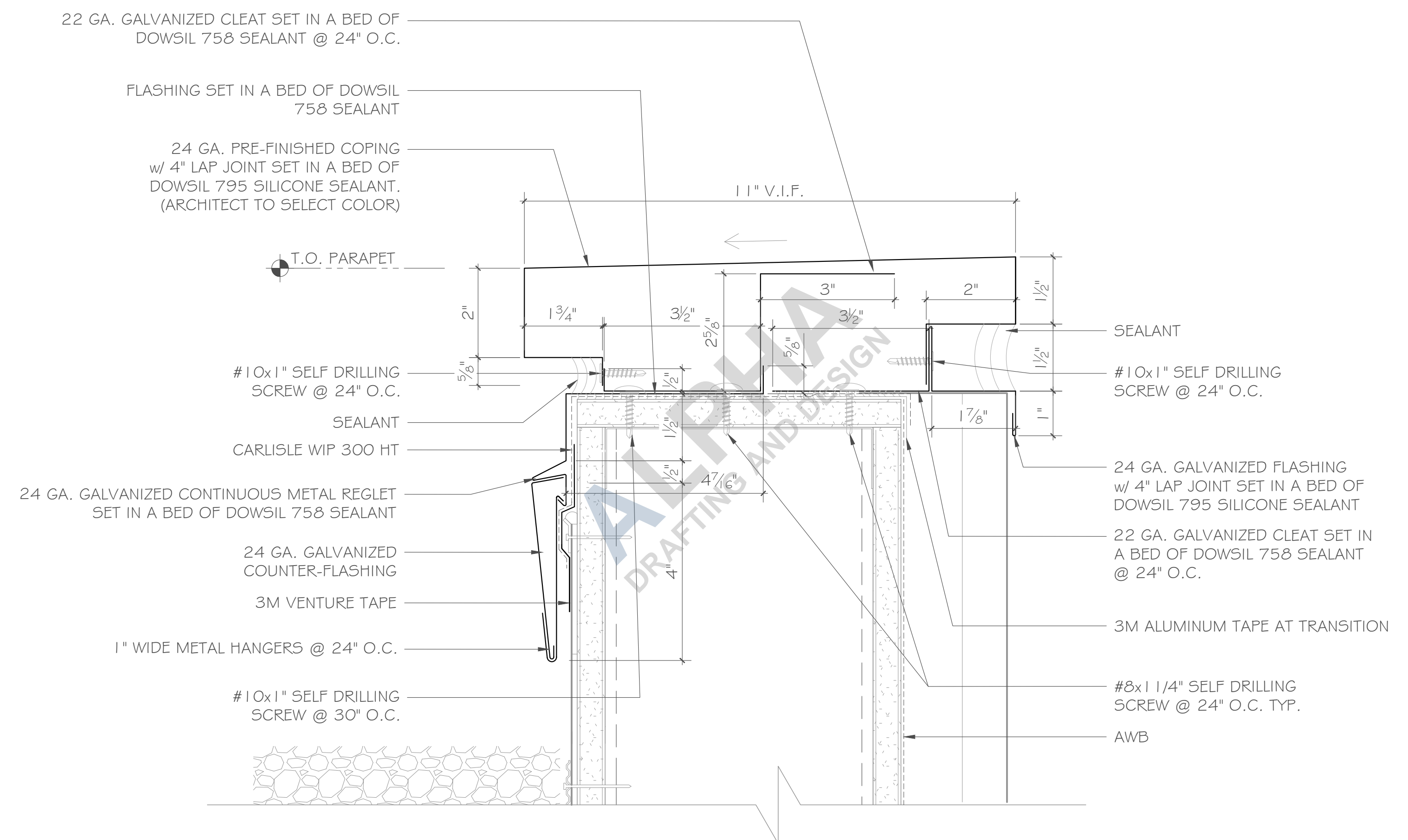

4 PAVILLION ROOF COPING AT RO2
SCALE: 6"=1'-0"

REF: 3/A9.507

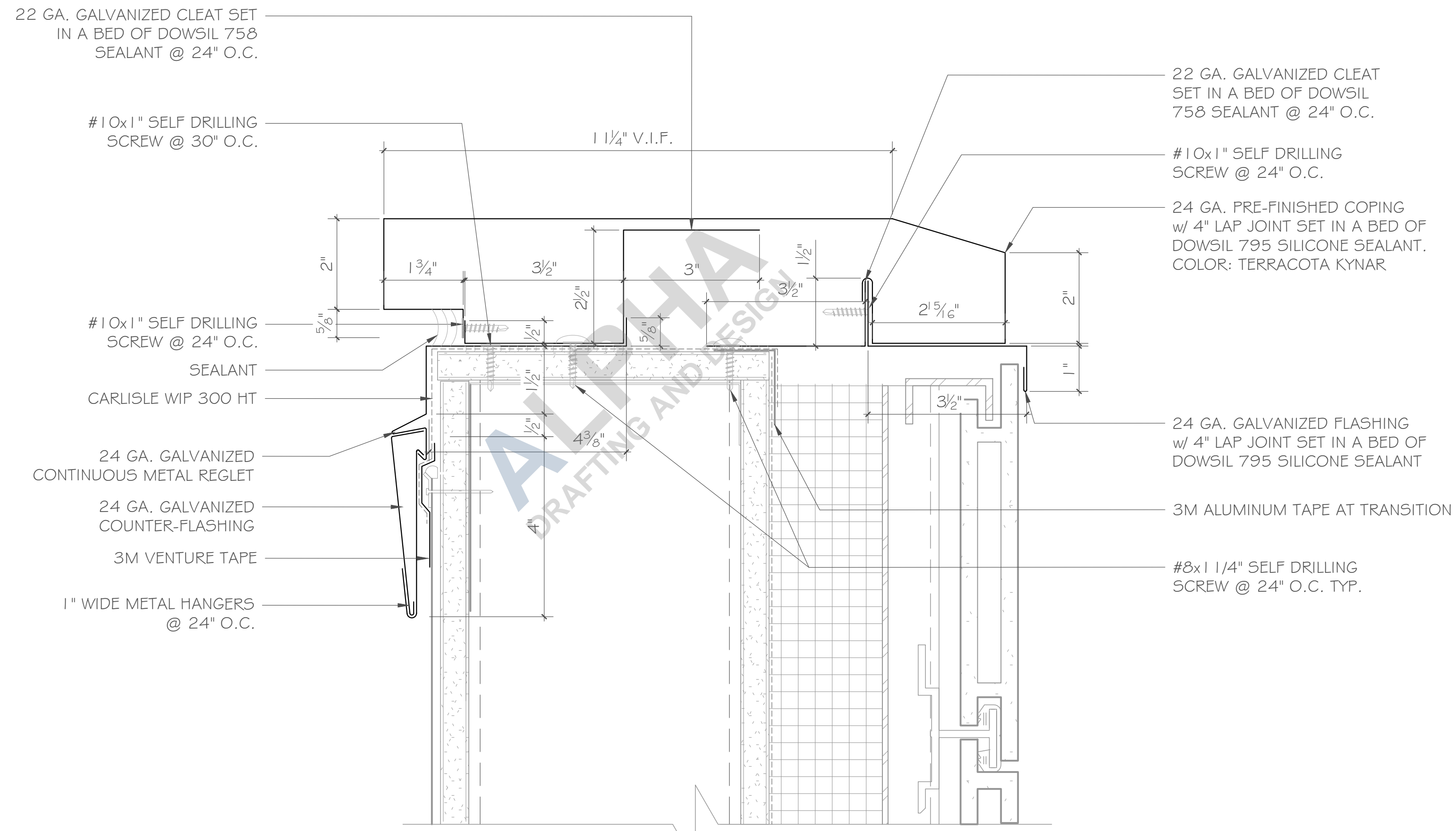

1 TERRACOTTA WALL COPING AT RO2
SCALE: 6"=1'-0" REF: 5/A9.507

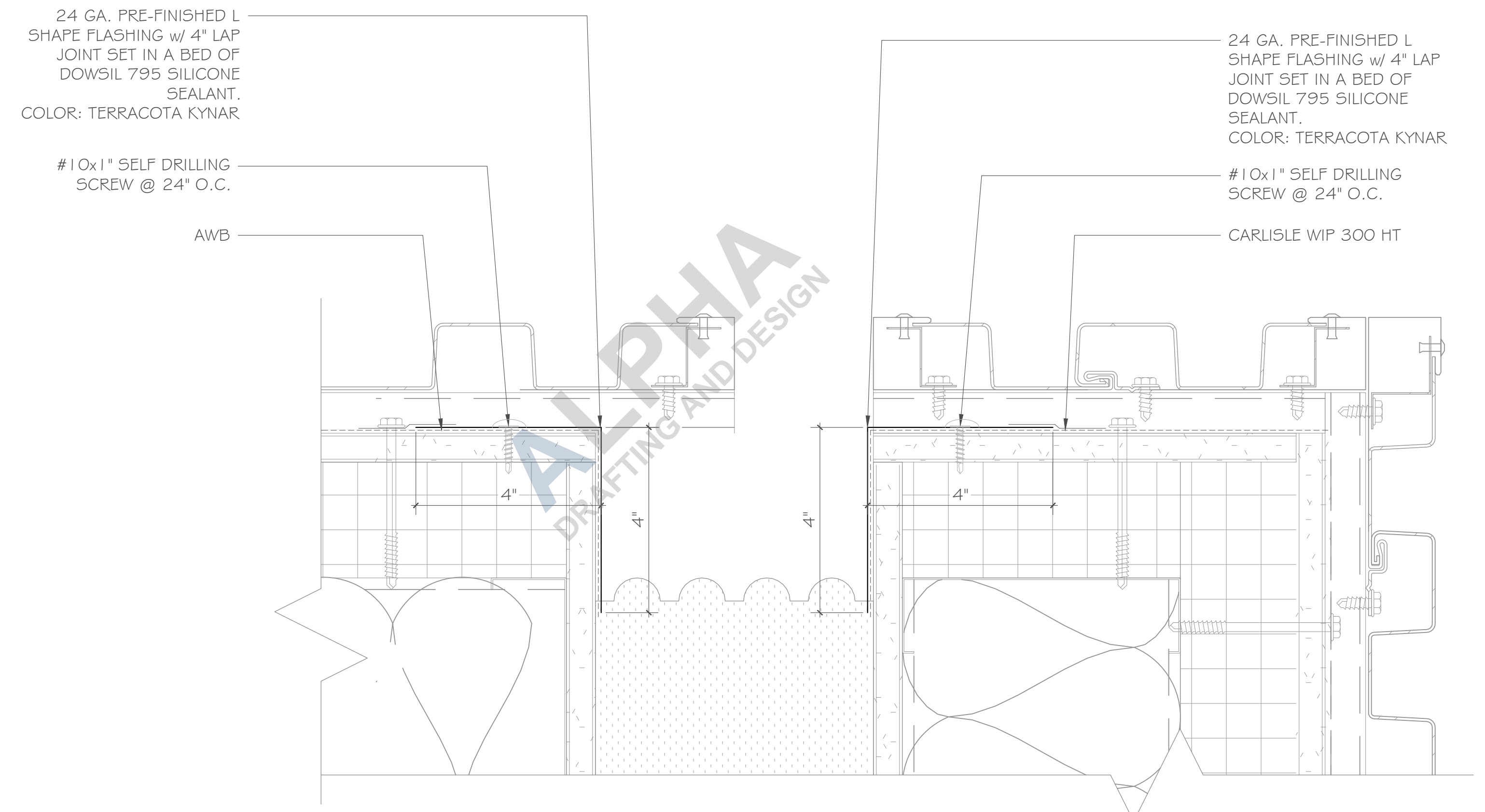

3 PLAN DETAIL - EW11A / EW12 CORNER TYP.
SCALE: 6"=1'-0" REF: 1/A9.450

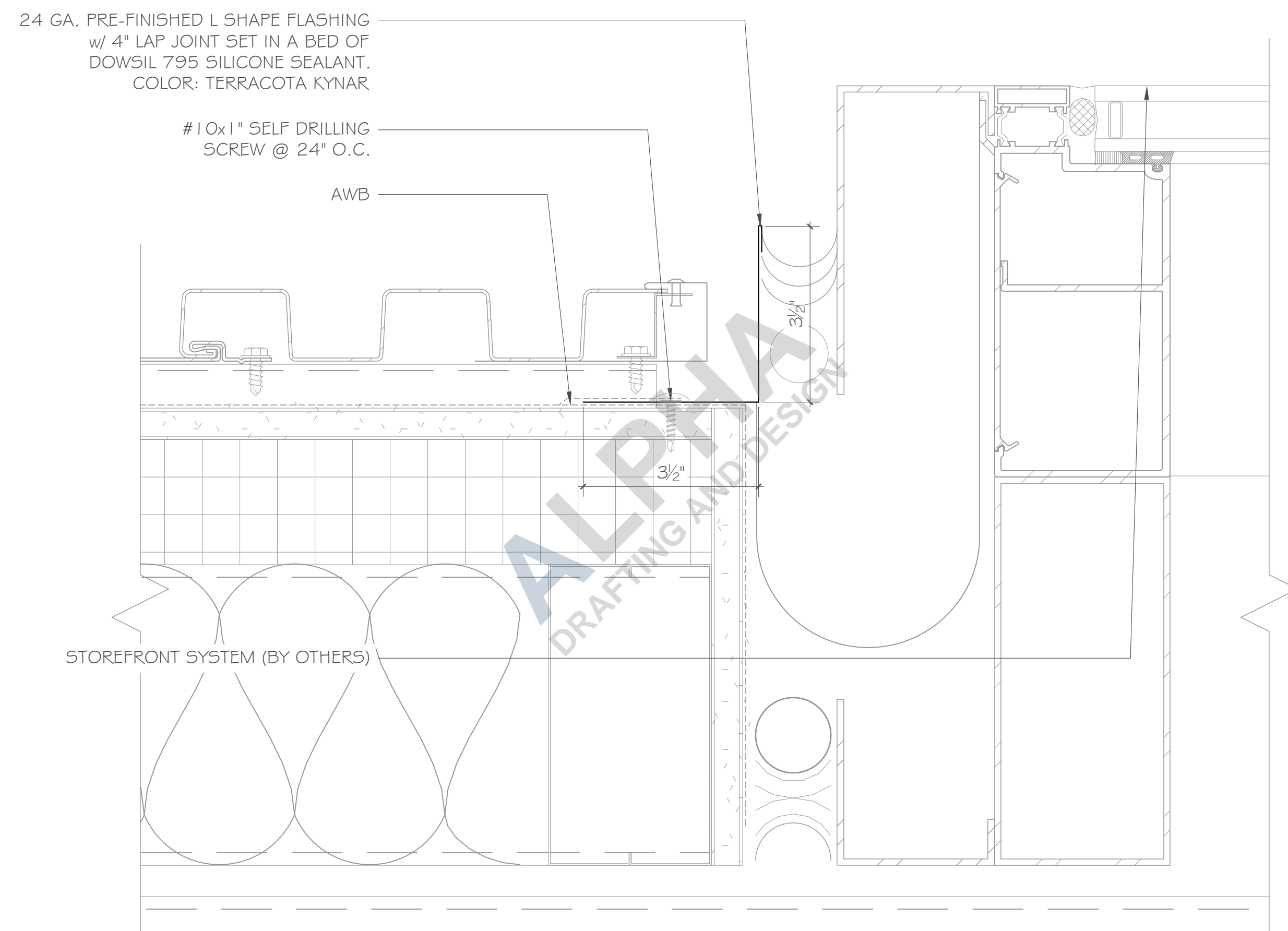

2 PLAN DETAIL - EW12 TO WW12 STOREFRONT WALL
SCALE: 6"=1'-0" REF: 5/A9.450

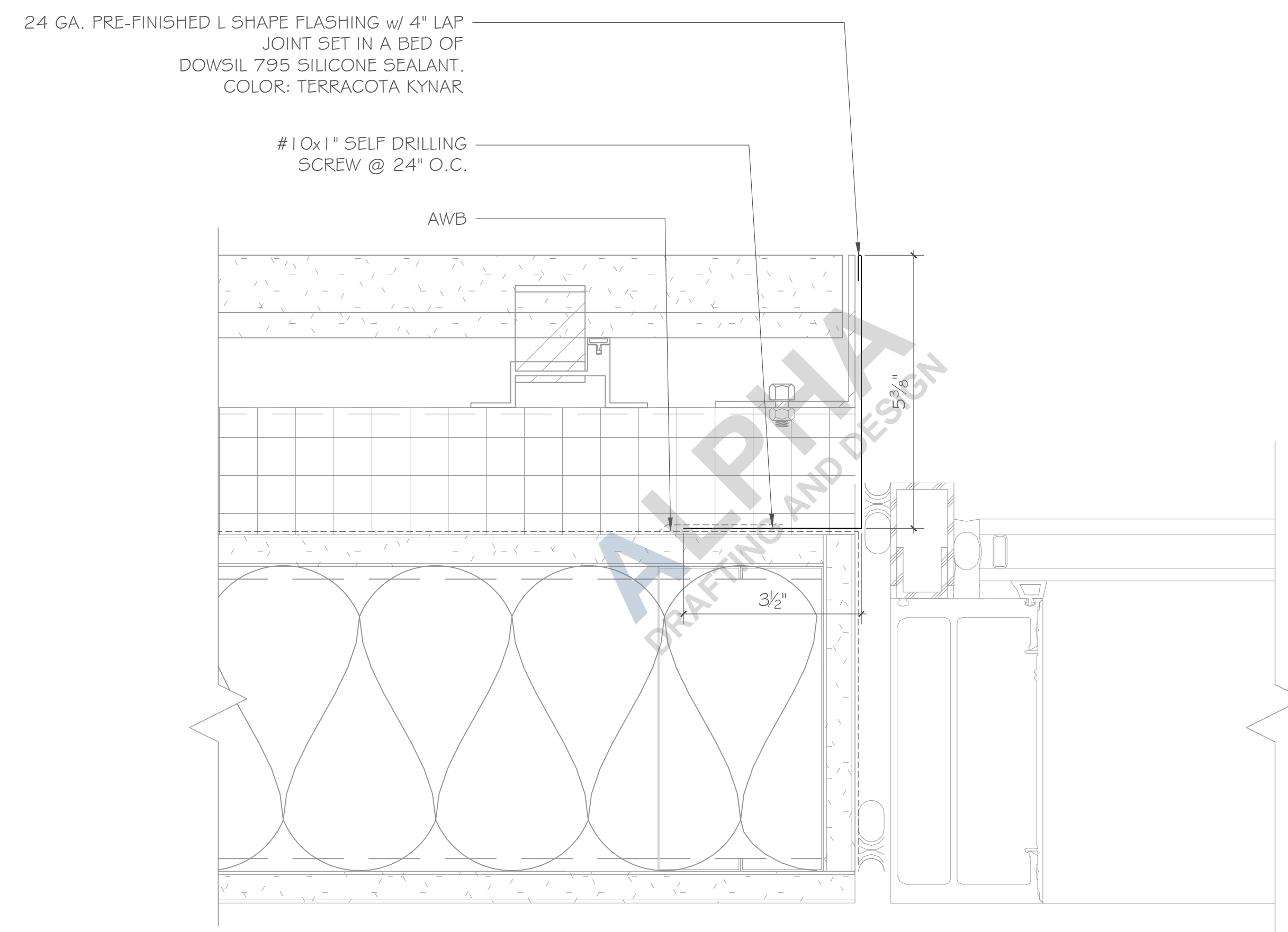

4 PLAN DETAIL - EW15 TO WW11
SCALE: 6"=1'-0" REF: 8/A9.450

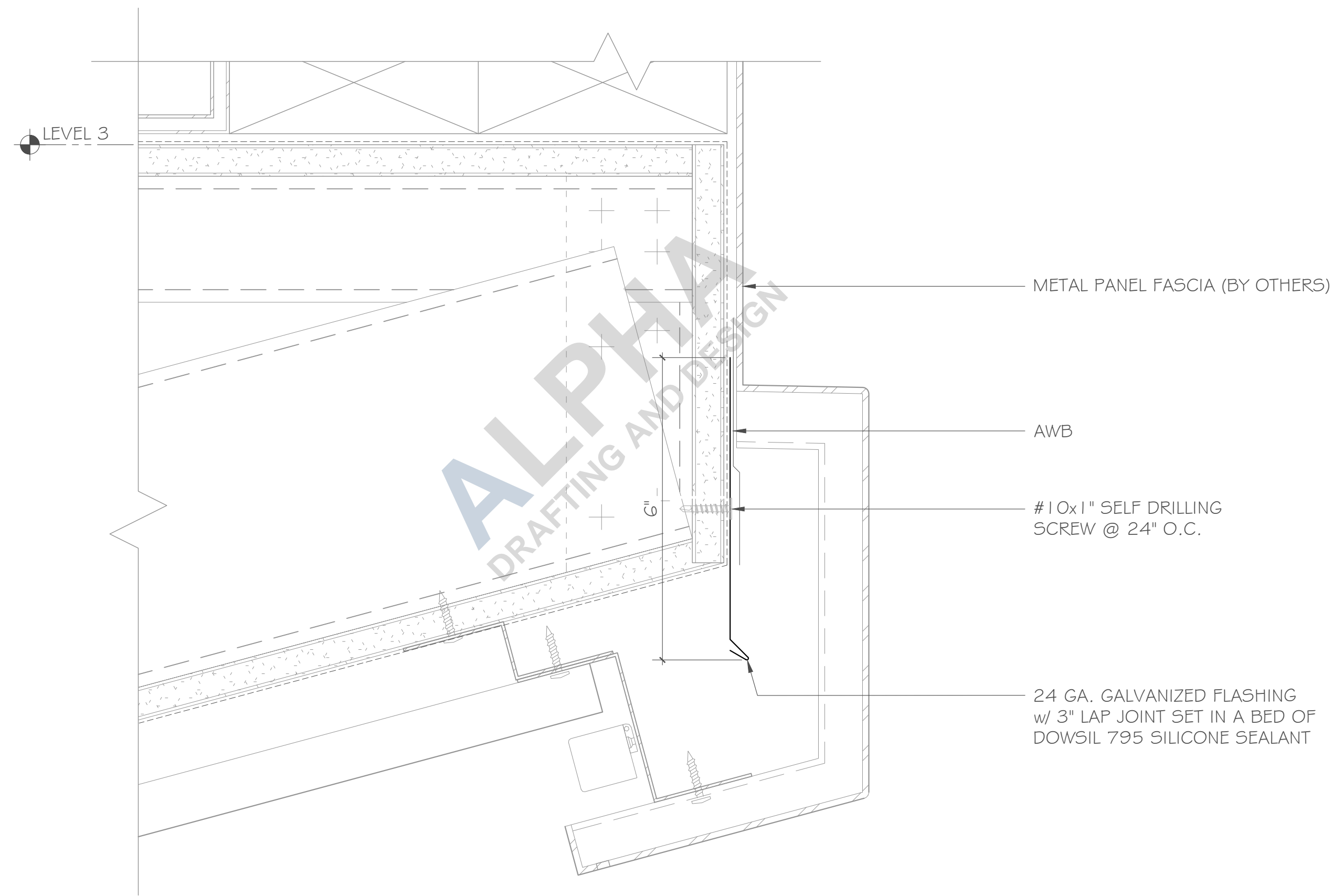

1 PAVILION ROOF GUTTER AT R02
SCALE: 6"=1'-0" REF: 6/A9.507

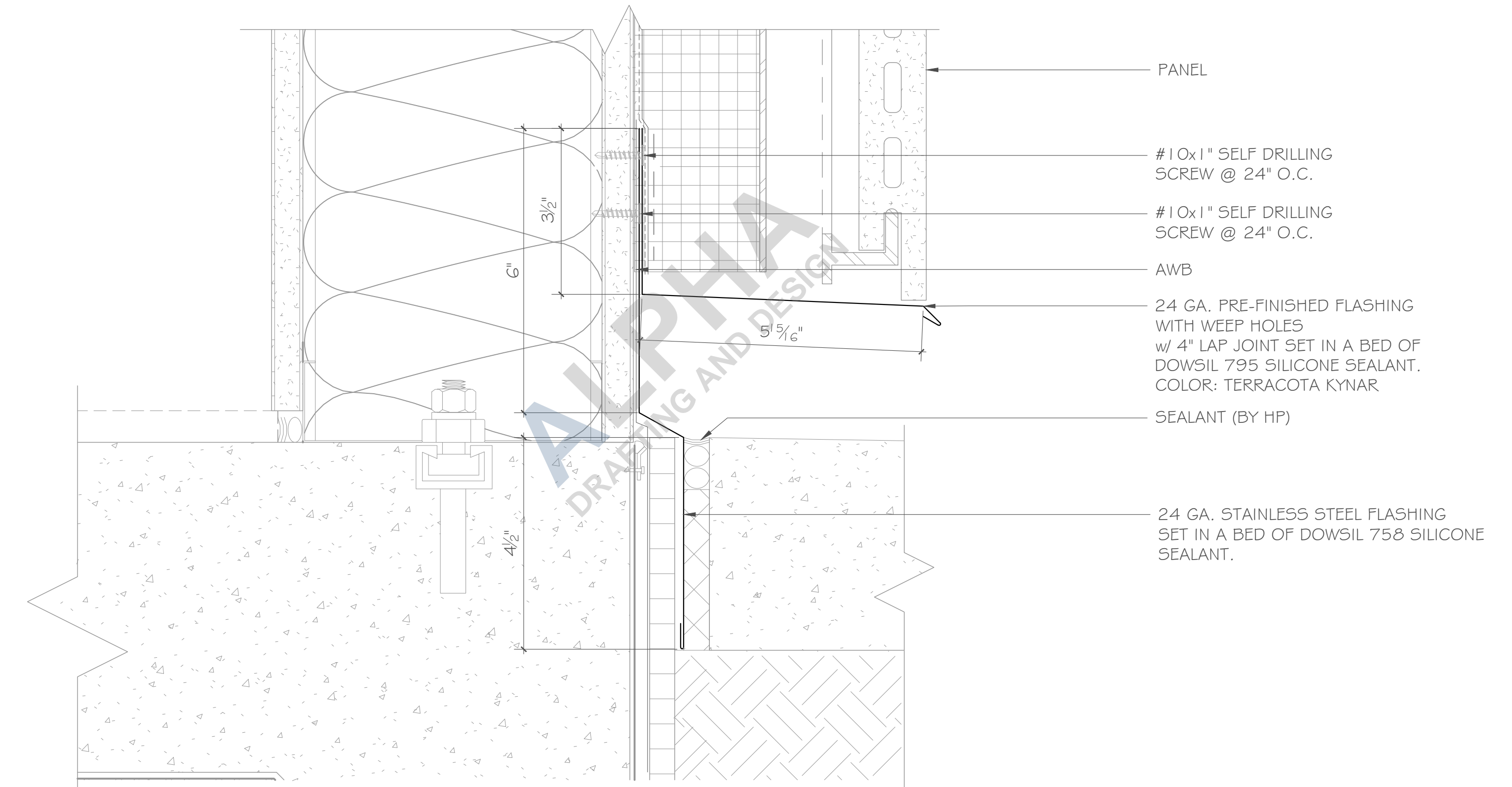

3 EXTERIOR TERRACOTTA PANEL AT GRADE / EXT. PAVING
SCALE: 6"=1'-0" REF: 4/A9.507B

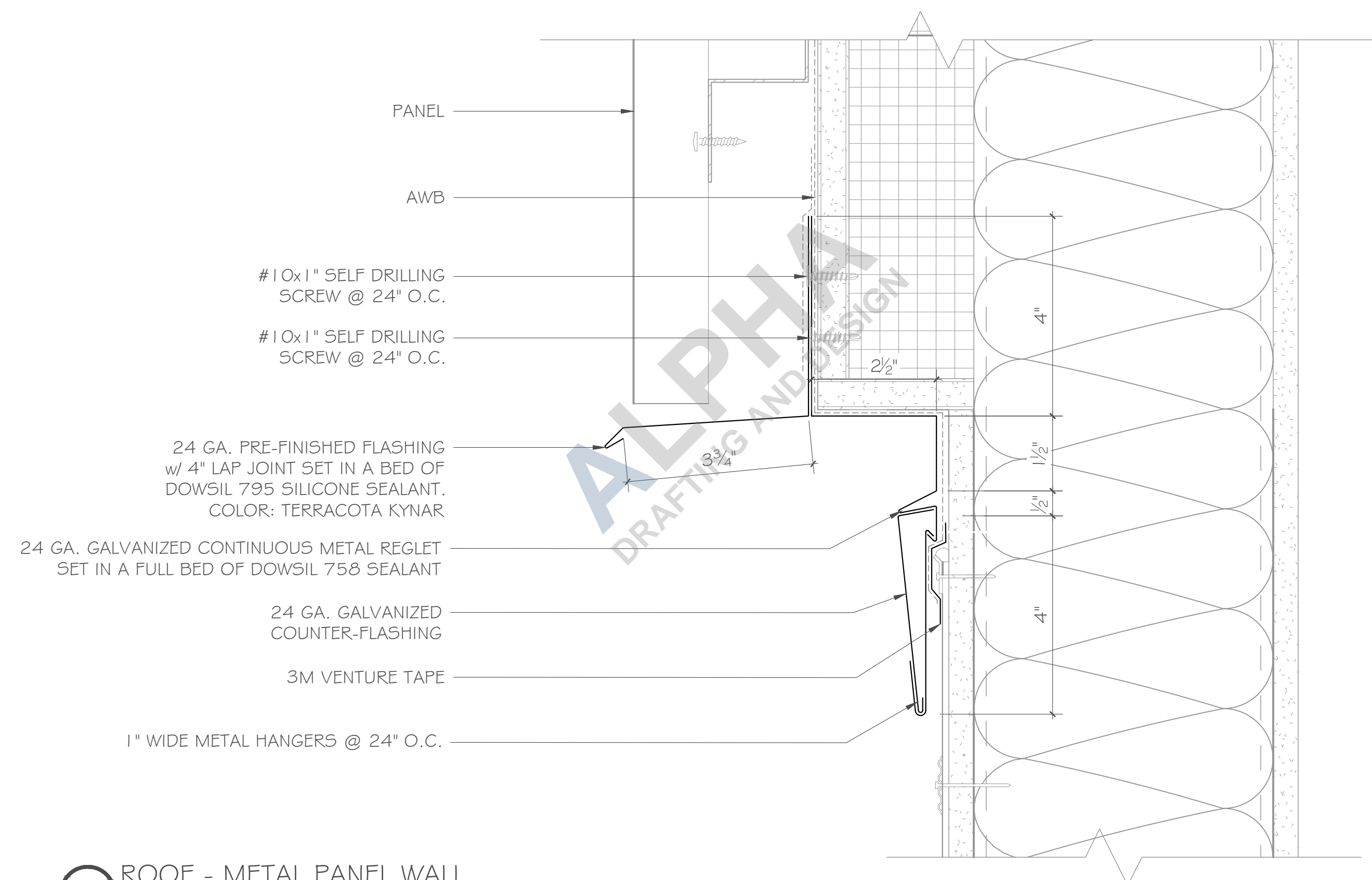

2 ROOF - METAL PANEL WALL
SCALE: 6"=1'-0" REF: 6/A9.506

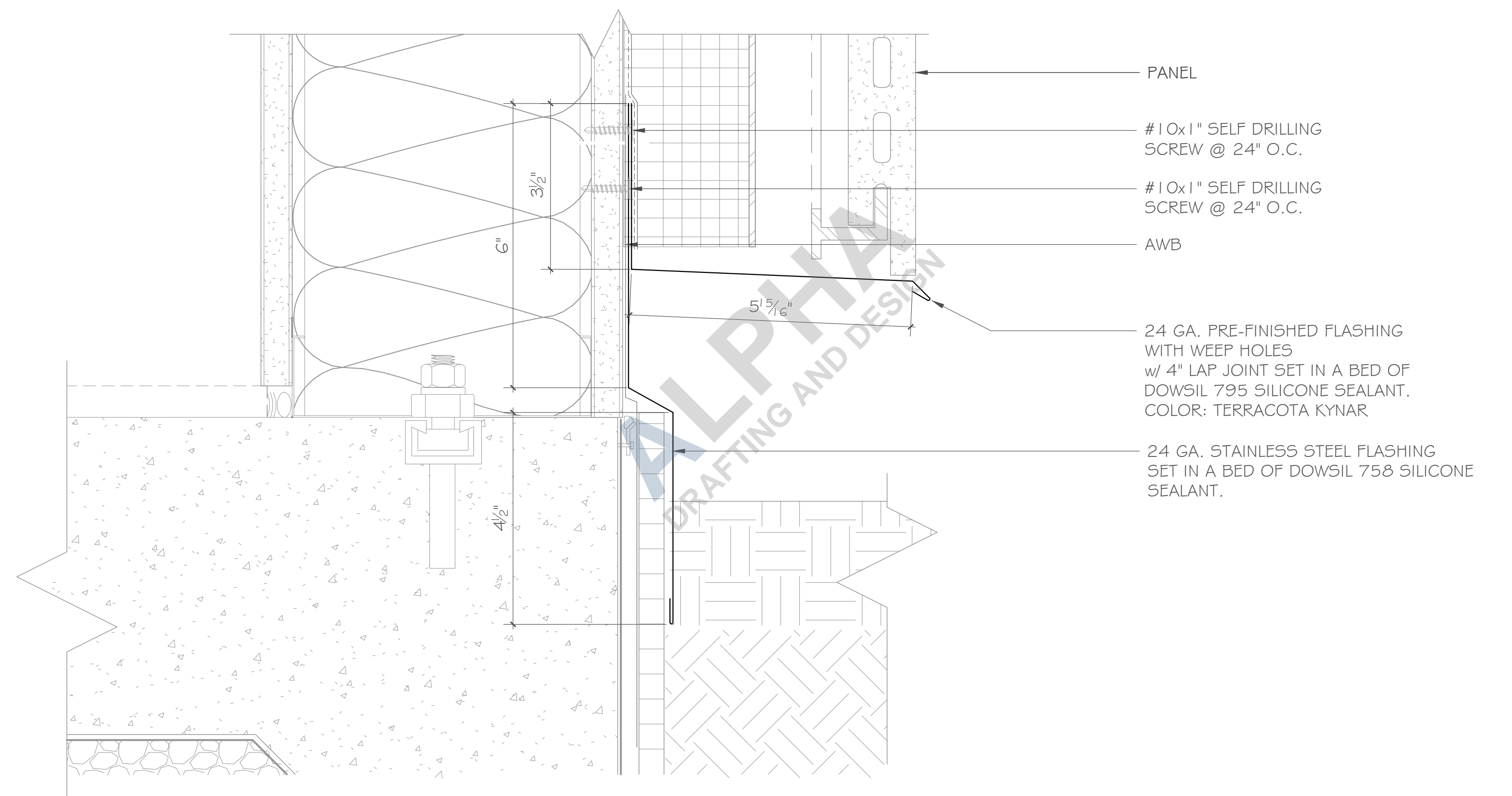

4 EXTERIOR TERRACOTTA PANEL AT GRADE / LANDSCAPING
SCALE: 6"=1'-0" REF: 5/A9.507B

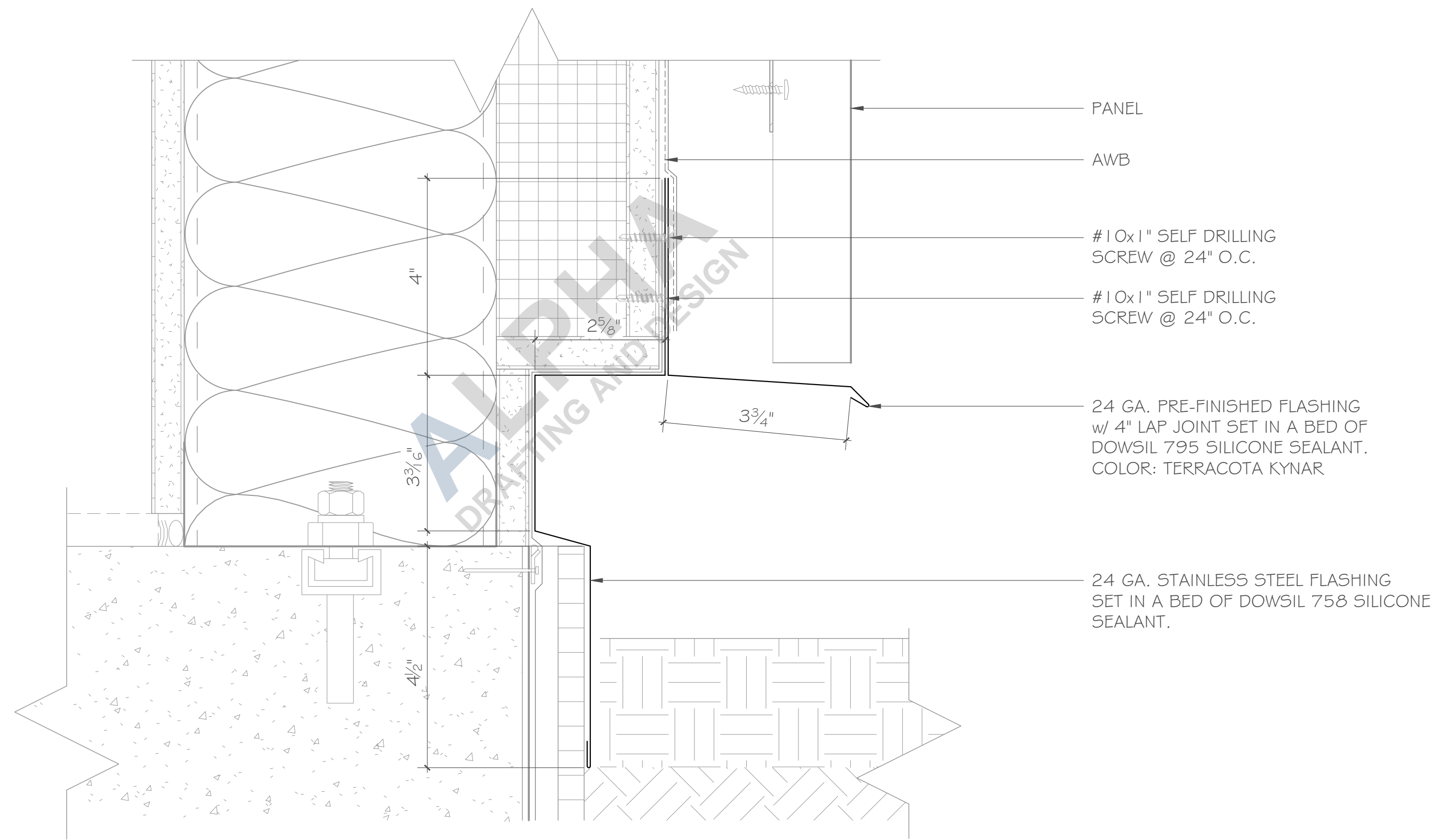

1 FOUNDATION - EXTERIOR METAL PANEL AT GRADE / LANDSCAPING
SCALE: 6"=1'-0" REF: 8/A9.507B

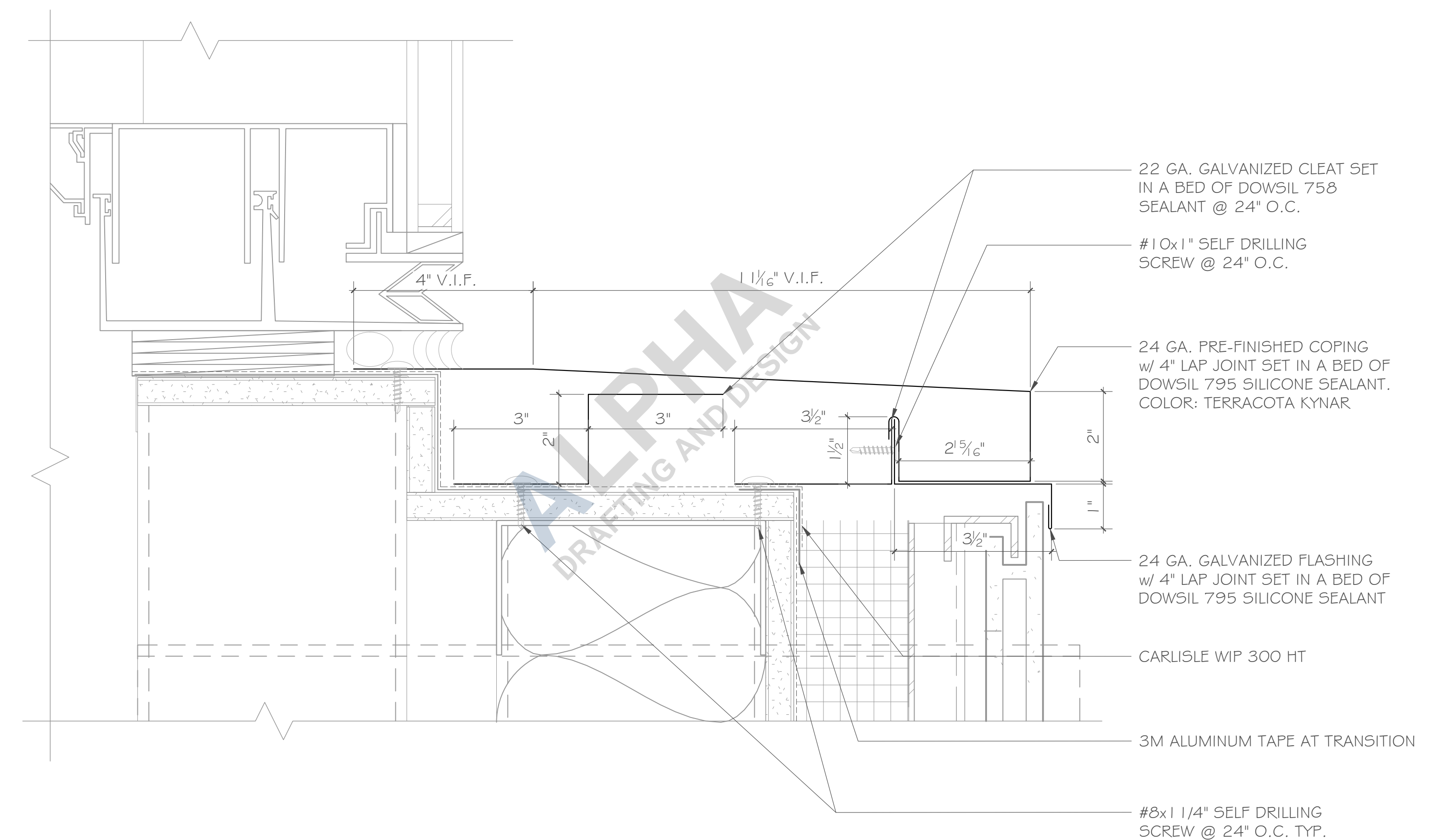

3 LEVEL 4 - TERRACE GLASS RAIL
SCALE: 6"=1'-0" REF: 2/A9.602

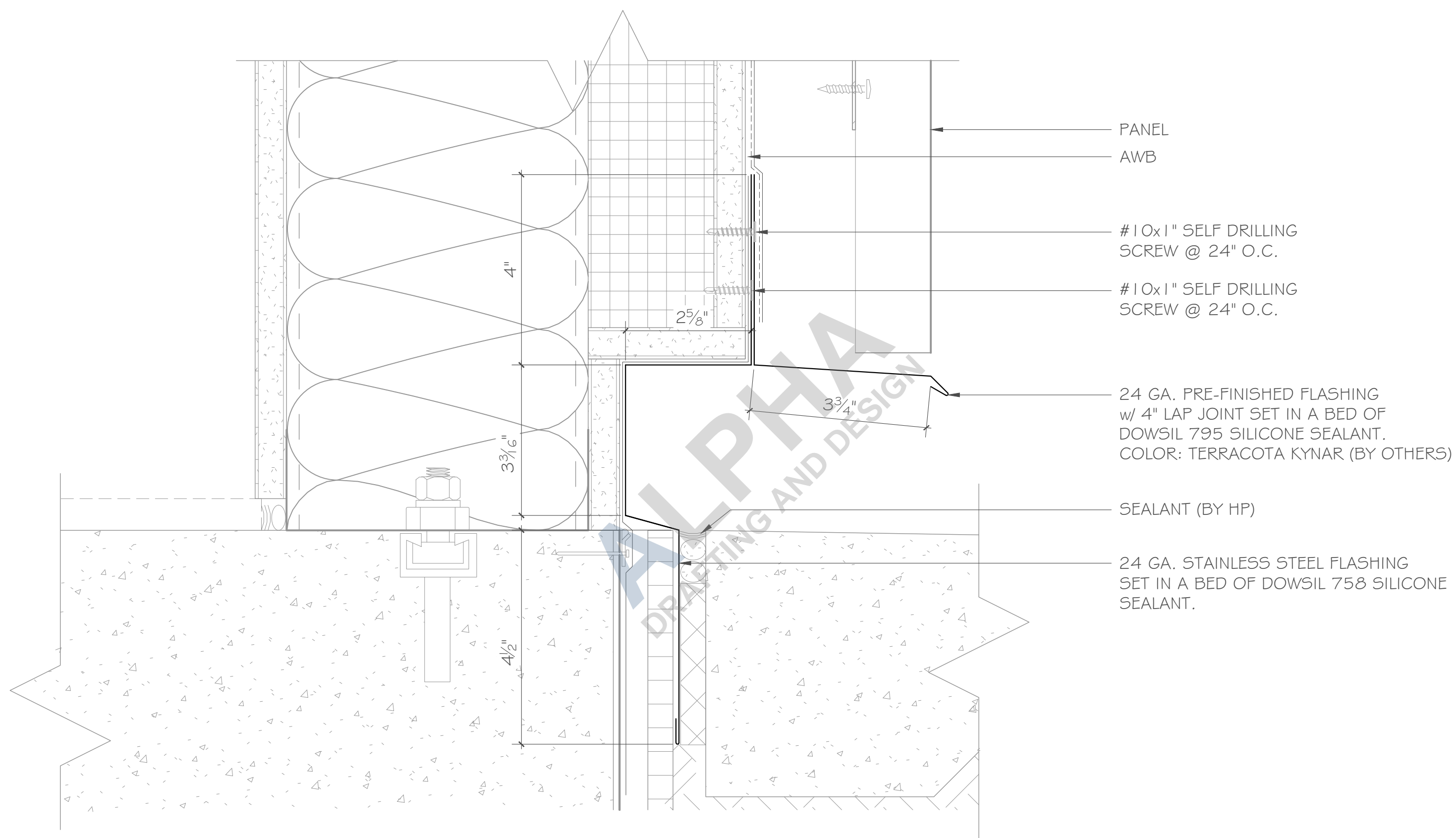

2 FOUNDATION - EXTERIOR METAL PANEL AT GRADE / EXT. PAVING
SCALE: 6"=1'-0" REF: 9/A9.507B

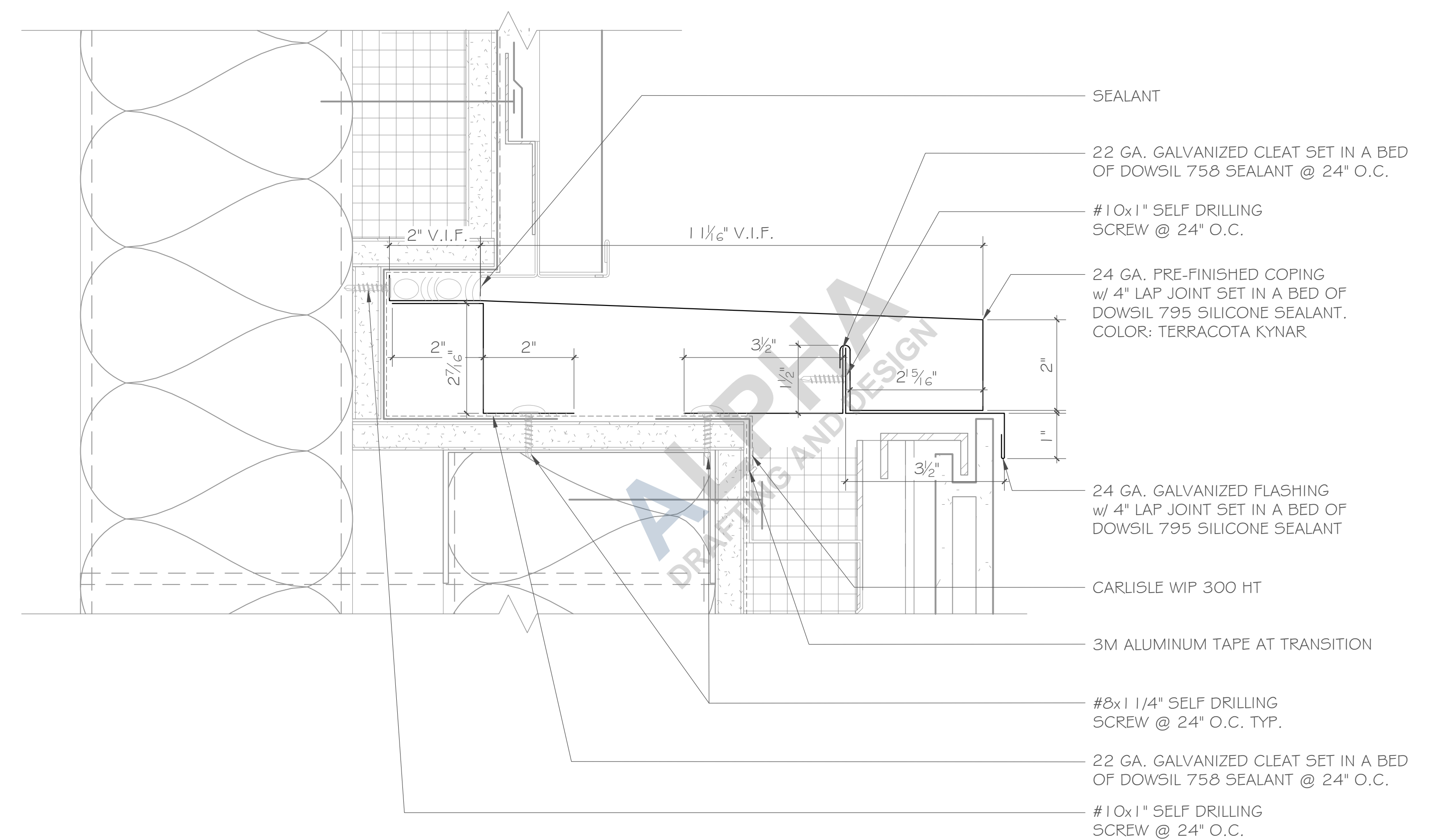

4 EW 15 TO EW 12 SILL
SCALE: 6"=1'-0" REF: 3/A9.602

ALPHA
DRAFTING AND DESIGN

ALPHA
DRAFTING AND DESIGN

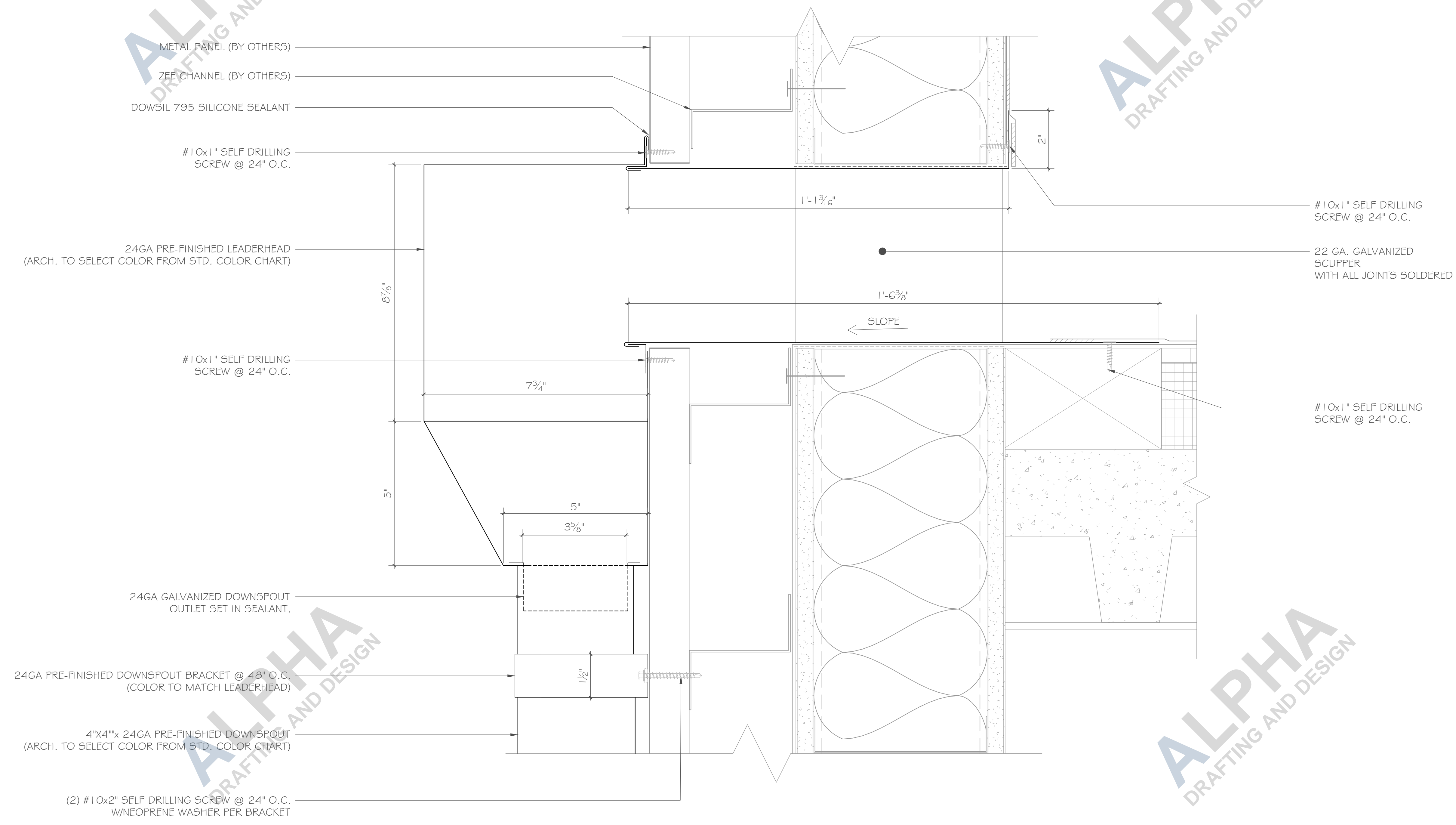

ALPHA
DRAFTING AND DESIGN

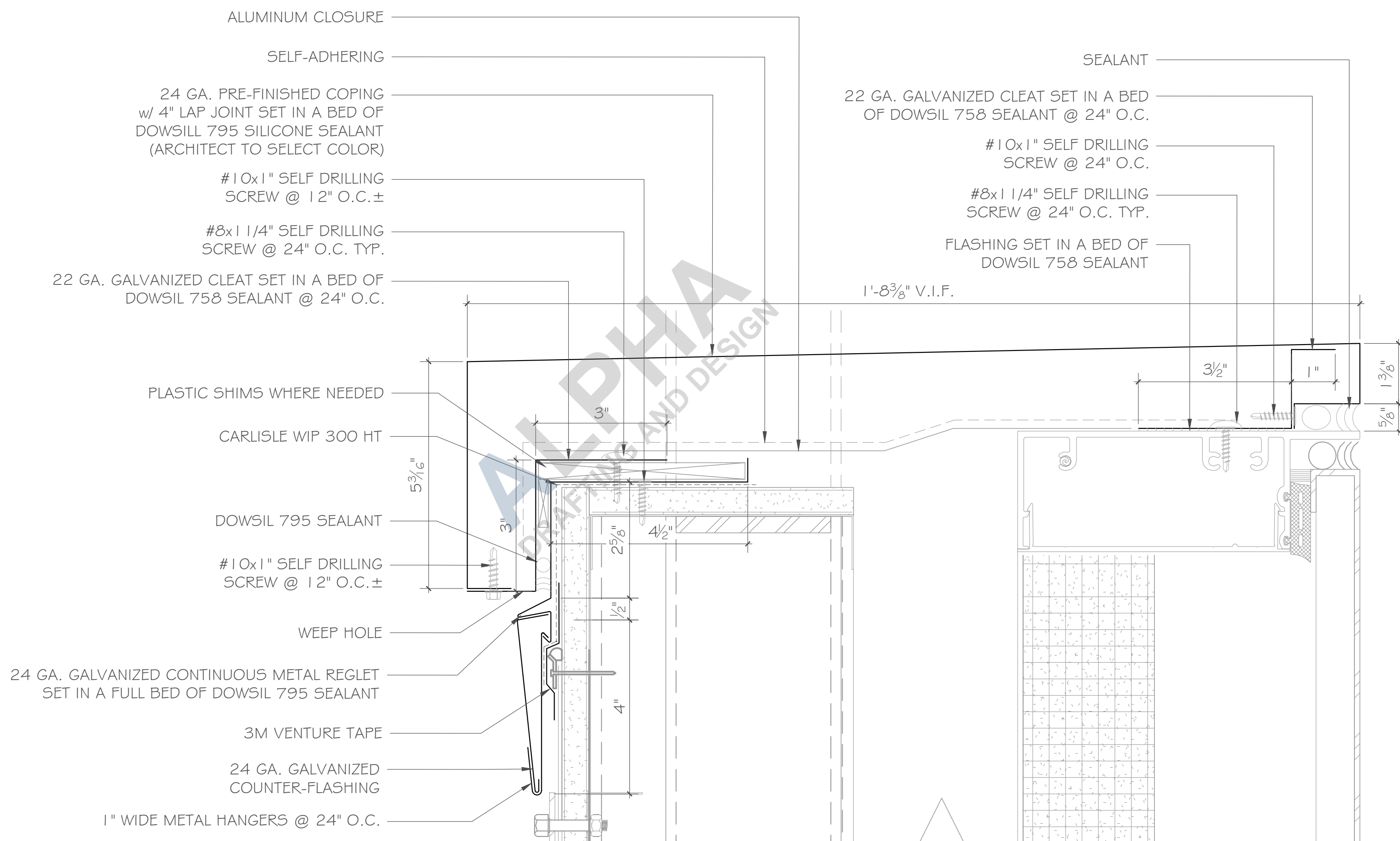

1 MAIN ROOF COPING AT ROI
SCALE: 6"=1'-0"

REF: 1/A9.507

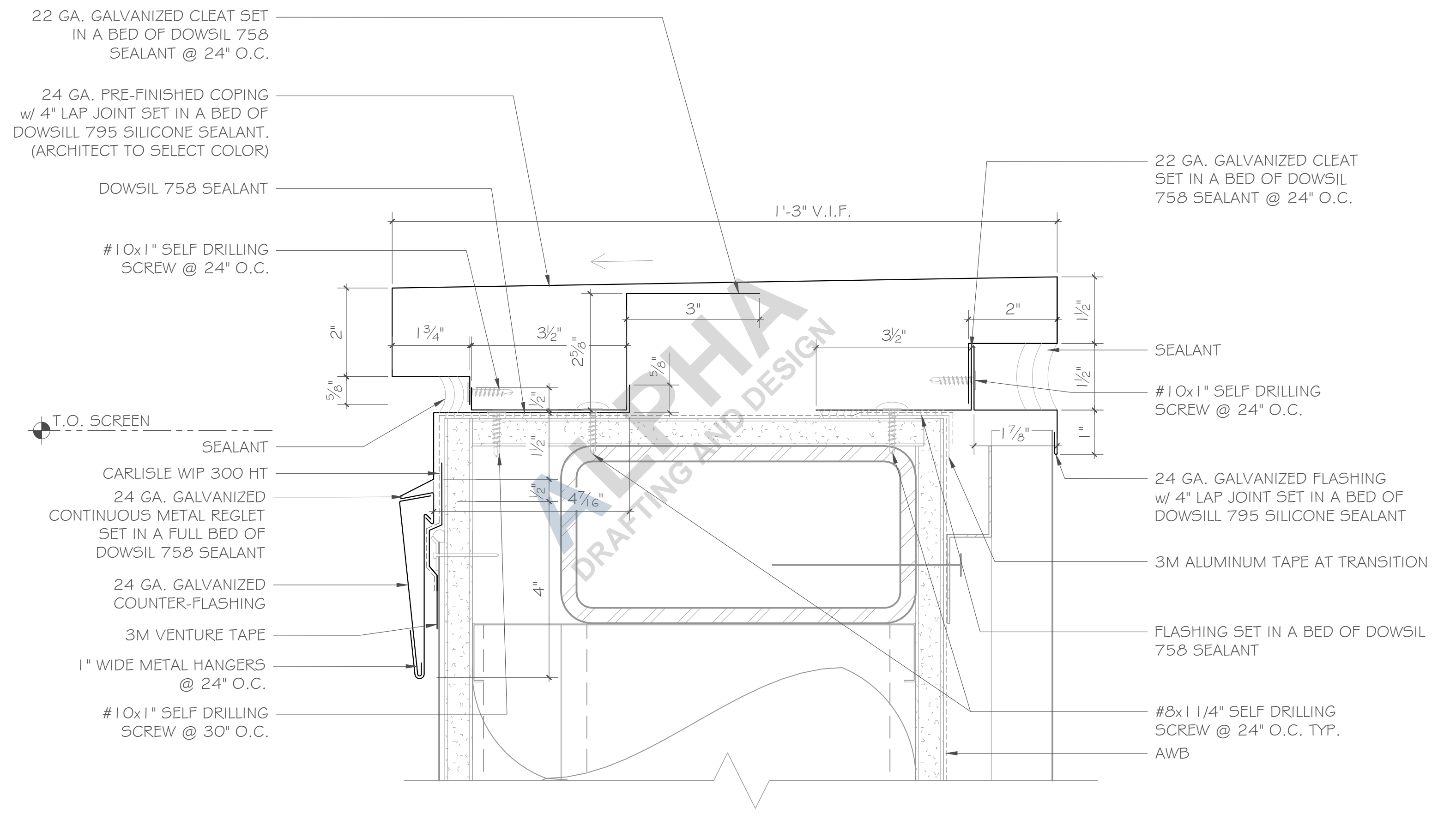

3 ROOF MONITOR TO SCREEN
SCALE: 6"=1'-0"

REF: 2/A9.424

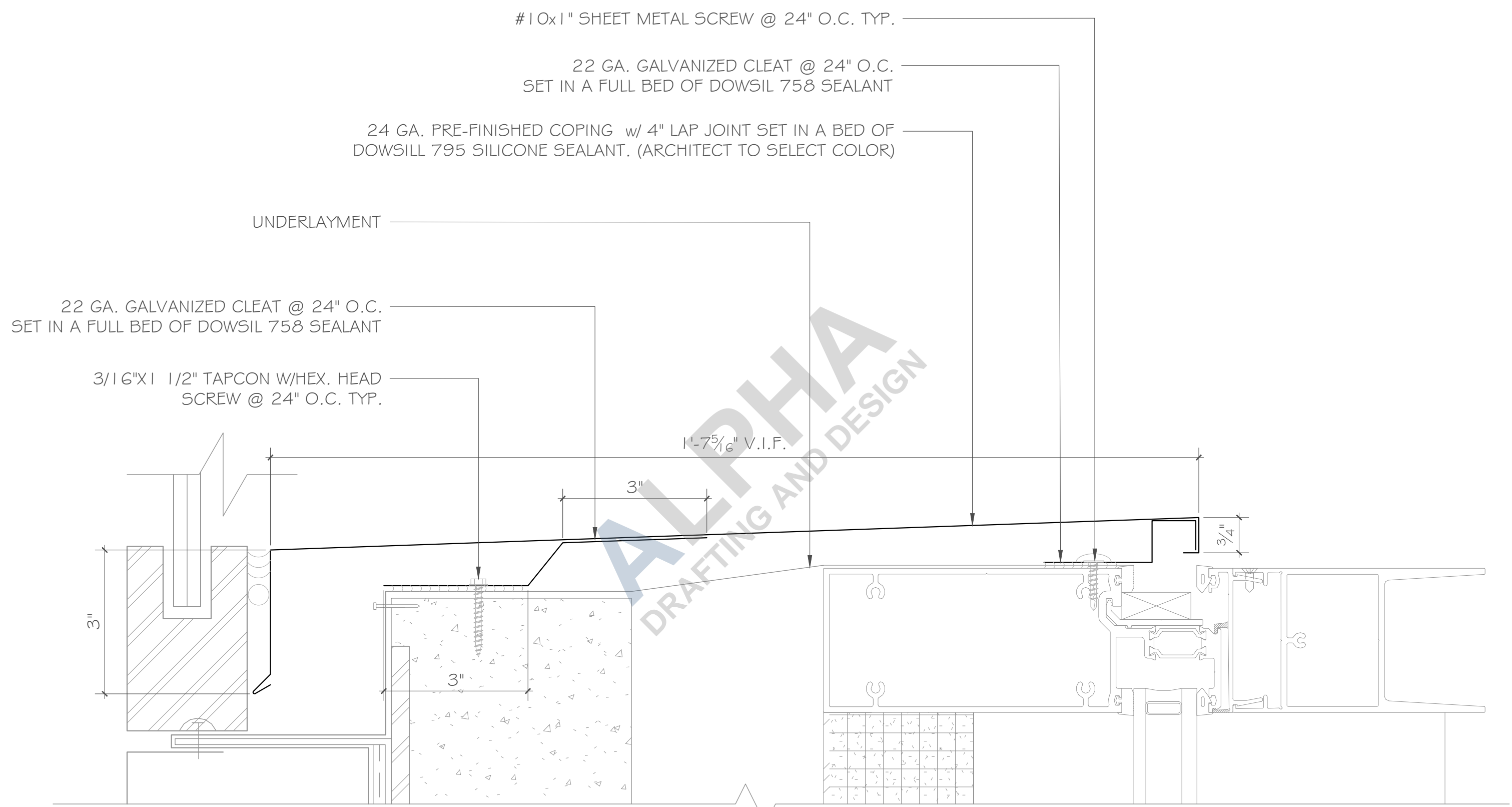

2 LEVEL 4 - TERRACE GLASS RAIL
SCALE: 6"=1'-0"

REF: 5/A9.506

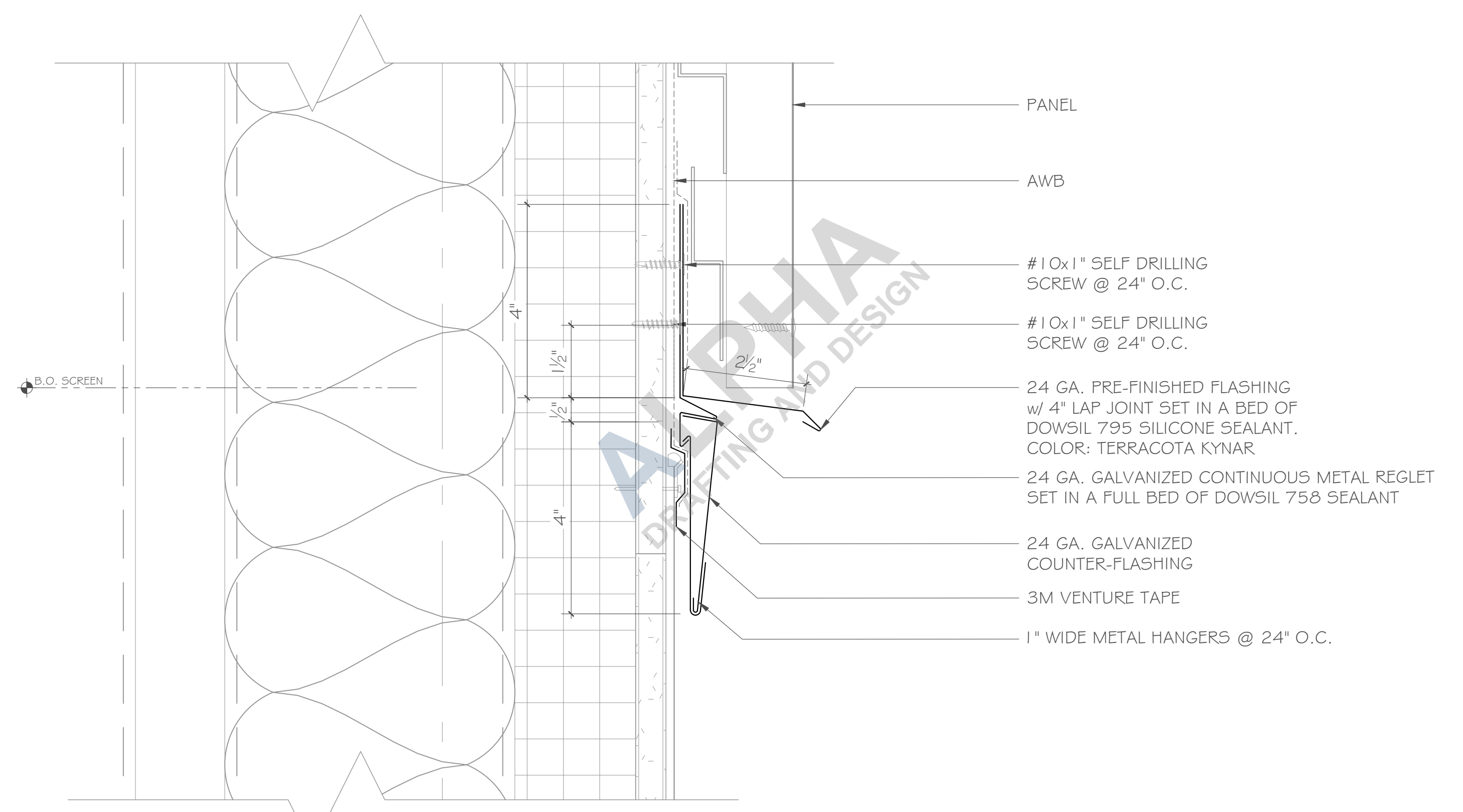

4 ROOF MONITOR TO SCREEN
SCALE: 6"=1'-0"

REF: 2/A9.424

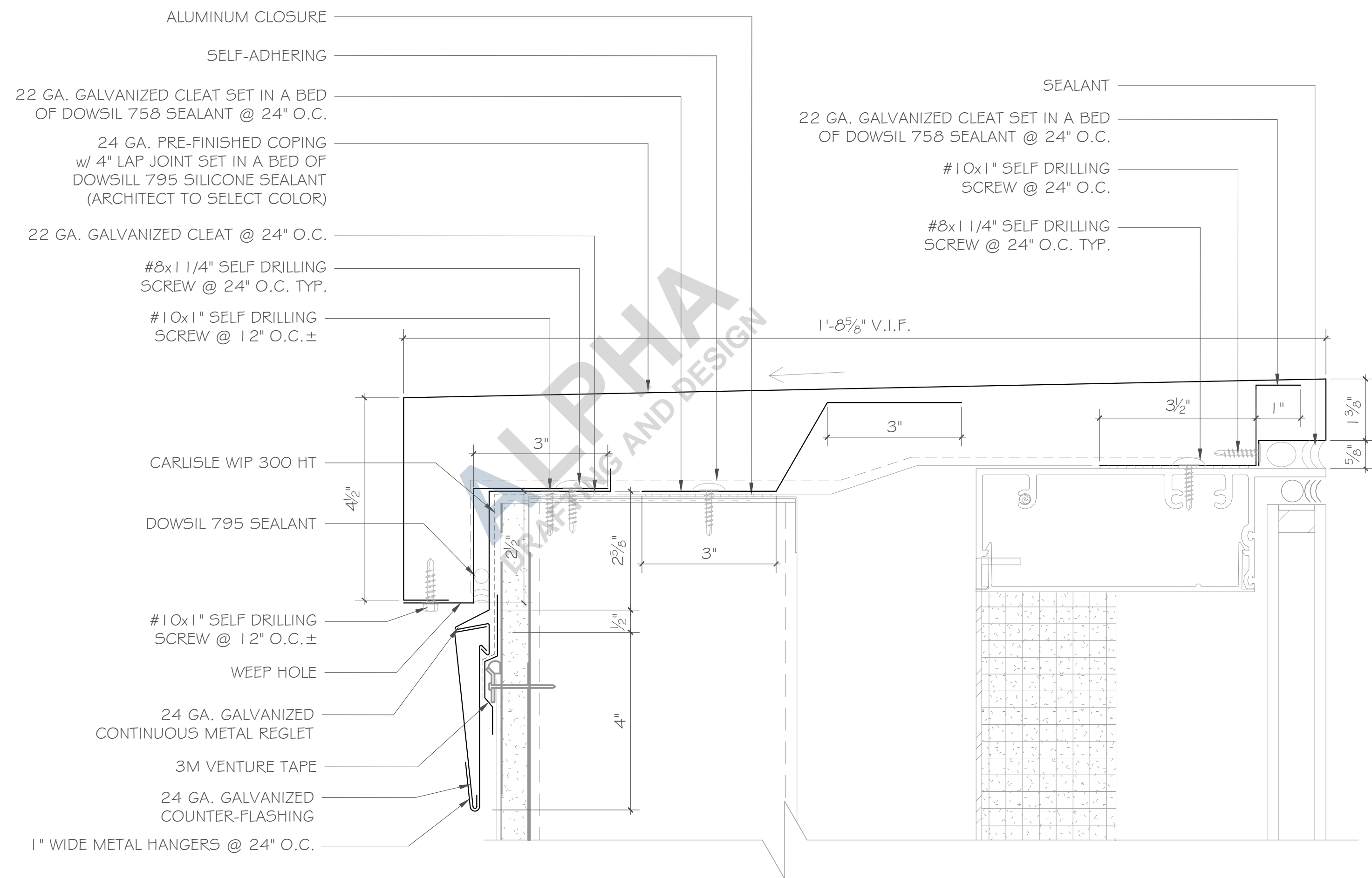

1 WW 12 MAIN ROOF COPING AT ROI
 SCALE: 6"=1'-0"
 REF: 2/A9.507

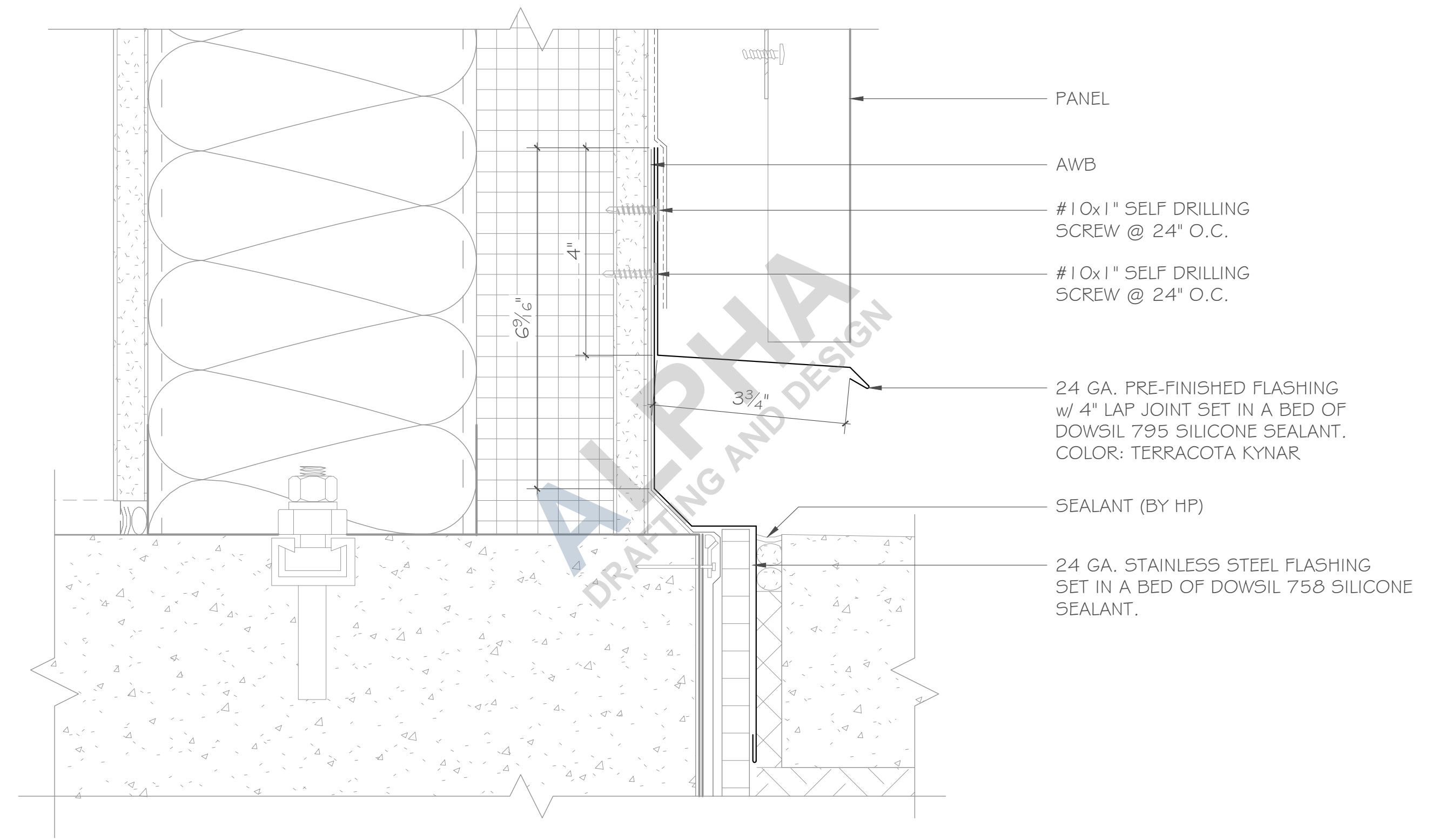

3 EXTERIOR METAL PANEL AT GRADE / EXT. PAVING
 SCALE: 6"=1'-0"
 REF: 7/A9.507B

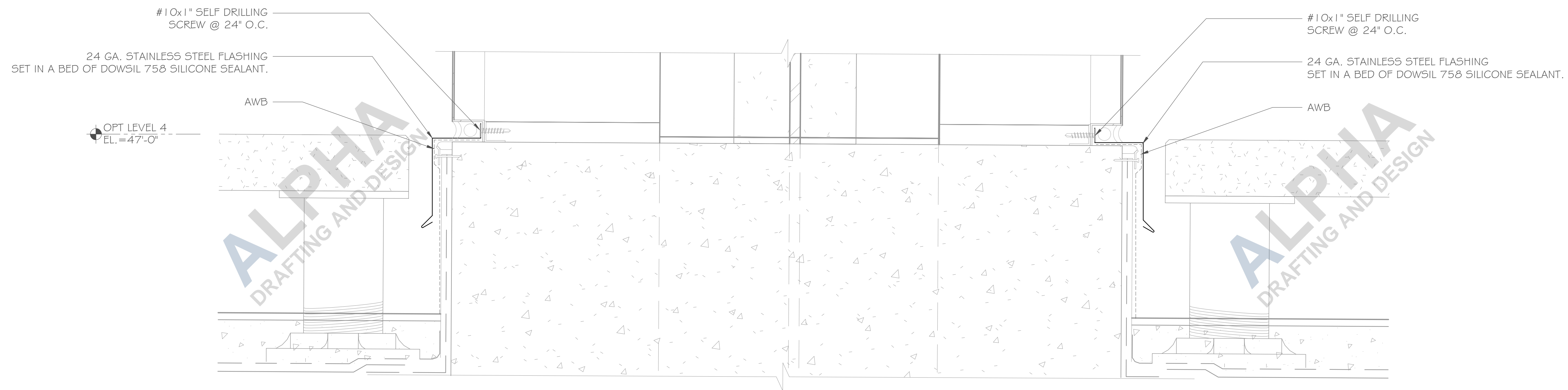

2 COLUMN @ L4 TERRACE
 SCALE: 6"=1'-0"
 REF: 13/A9.454